

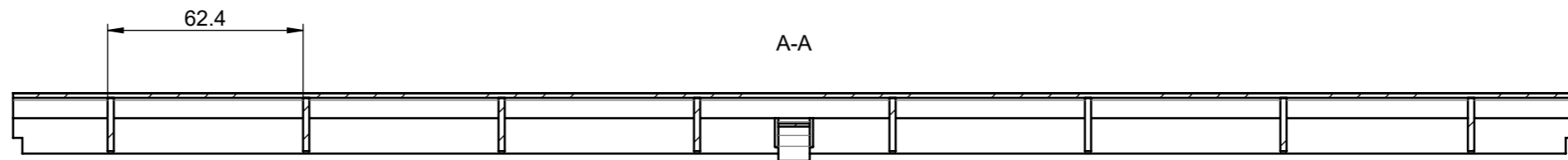

SCALE 1 : 5

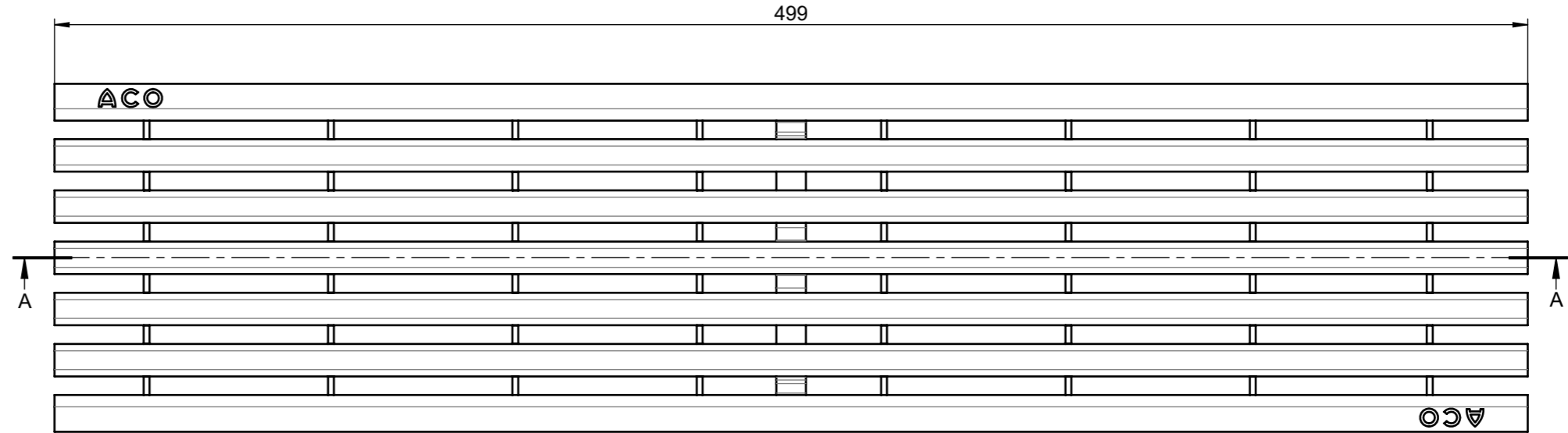
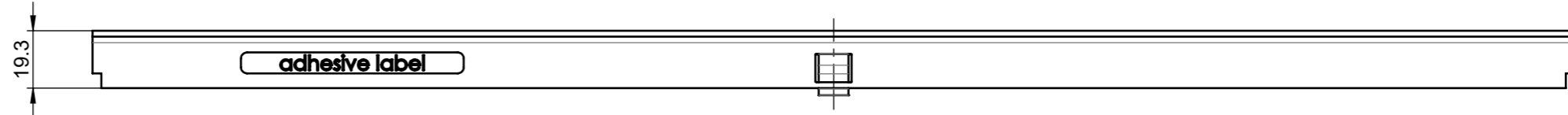
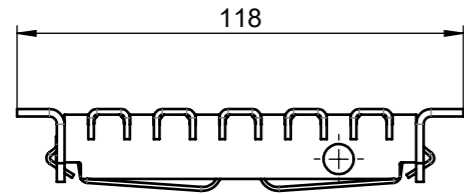
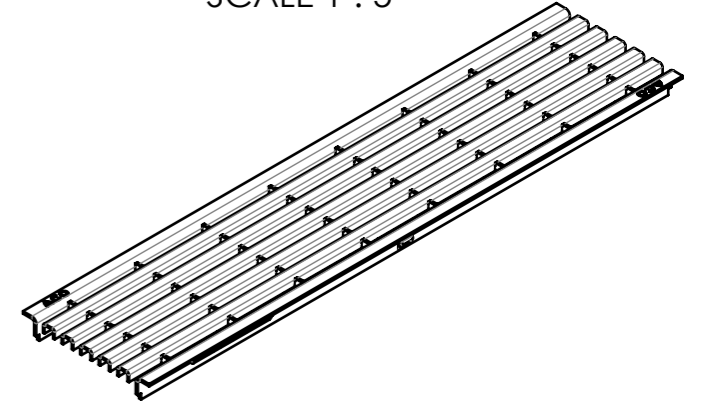

material number: 3003859

 ACO Hochbau Vertrieb GmbH Am Ahlmannkai 24782 Büdelsdorf www.aco.com	drawing-no.: <b>1173489-M</b>	index: <b>001</b>	documenttype: marketing drw.
	created by: vumasankar	reviewed by: Isigel	projection: ISO-E 
title: ACO Self Platform ASM Grate Self U Profile L499, galvanized steel ZB Self U-Profil-Rost L499, verzinkt			serial-released
The reproduction, distribution and utilization of this document as well as the communication of its contents to others without express authorization is prohibited. Offenders will be held liable for the payment of damages. All rights reserved in the event of the grant of a patent, utility model or design. Observe copyright by ISO 16016			release date: 14.04.2023
			sheet: 1/1

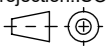
S:\projekte\2019\001\_A3\_Vertrieb\22